

Installation — Operation — Care



PowerView® Gen 3 Automation Drapery Hardware

carole[™]

CONTENTS

GETTING STARTED	1
Tools and Hardware You May Need.....	1
Bracket Types.....	2
INSTALLATION	3
Bracket Spacing.....	3
Spliced Tracks.....	3
Attach Finials.....	4
Hang the Brackets.....	4
Hang the Rod.....	5
Hang the Drapery.....	5
Install the Motor.....	6
Setting Close and Open Limits.....	7
Testing the Drapery.....	7
OPERATION.....	8
Operating the PowerView App and Gen 3 Remote.....	8
Resetting the Drapery.....	10
Set Drapery Speed.....	11
TROUBLESHOOTING	12
DECLARATIONS.....	14

Questions?

Call the Carole Fabrics Customer Service Department at **(800) 241-0920**.

Tools and Hardware You May Need (not included)

- Tape measure
- Flat-blade or philips screwdriver
- Pencil
- Drill with bits
- Scissors or Utility knife
- Spirit level
- Drill with bits
- ¼" Nutdriver
- Drywall anchors
- Ladder

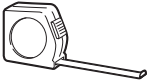

Tape measure

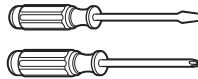

Flat-blade or philips screwdriver



Pencil

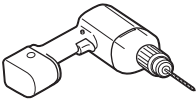

Drill with Bits

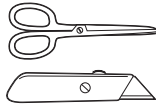

Scissors or Utility Knife



Spirit Level



¼" Nutdriver

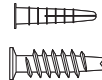

Drywall anchors



Ladder

GETTING STARTED

There Are Four Different Bracket Types

- Hidden Bracket
- Over the Top Bracket
- Over the Top Double Bracket
- Ceiling Bracket

Bracket Weight Capacities

Hidden Bracket

24 lbs weight capacity

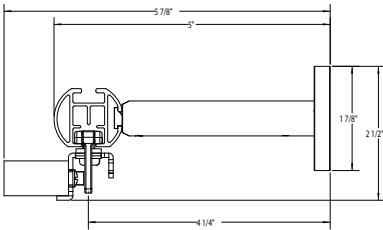

Ceiling Bracket

15 lbs weight capacity

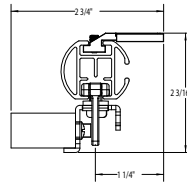

Over the Top Bracket

24 lbs weight capacity

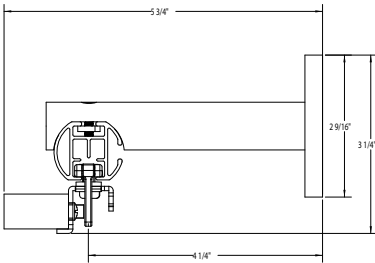

Over the Top Double Bracket

12 lbs weight capacity

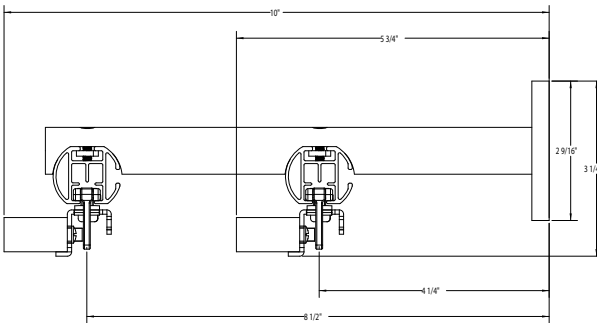

Instructions

■ Bracket Spacing

- When determining your bracket spacing a few rules need to be followed.
- Brackets should be placed at each end of the rod.
- From both ends, the next bracket is placed at a maximum of 24" from the first bracket on the end, then, place the remaining brackets at a maximum of 48" intervals evenly spaced along the remainder of the track.
- Spacing may need to be shortened for heavier draperies.

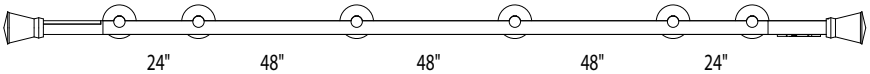

■ For Spliced Tracks

- To prepare for the splice reassembly, remove the two screws on top of the idle pulley, then, take off the bar, the top plate, and the pulley.

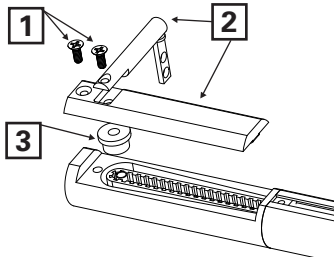

- Unfold the rods and line them up straight with each other while making sure the belts are not kinked between them.



- Take the slack out by moving the belt loop over the stem in the idle pulley. Then, put the pulley back in place along with the top plate, bar and screws.

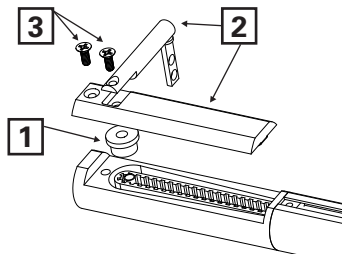

INSTALLATION

- Move the splice connector over to connect the two rods and tighten the set screws with a 2mm hex key provided with brackets.

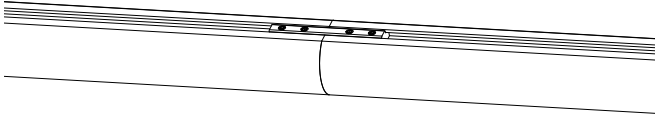

■ Attach Finials

- Put each finial on the rod and set the set screw using a 2mm hex key (included in box with finials).

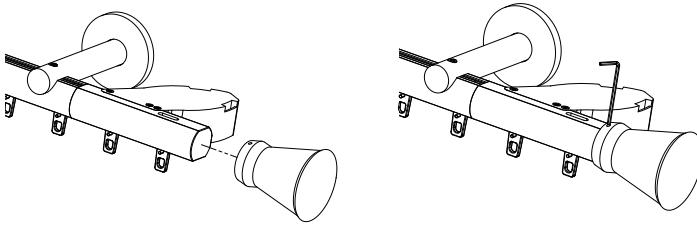

■ Hang the Brackets

- **For Hidden Brackets**, place the hidden bracket base on the wall and screw either into a stud or wall anchors.
- For heavier drapery it is recommended to add a screw in the top hole as well.
- Place the base cover on the base and screw the plug into the base to hold the cover.
- Slide the shaft over the plug and tighten the set screw using a 2mm hex key (included in box with brackets).

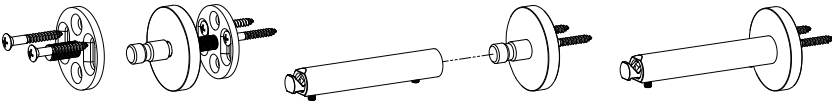

- **For Over The Top Brackets**, place base on the wall and screw either into a stud or wall anchors.
- Slide the base plate cover over the shaft and screw it onto the base.

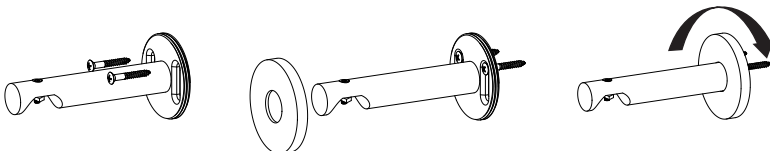

■ Hang the Rod

- **For Over The Top Brackets**, bring the rod under the bracket and turn the screw on top of the bracket until the rod is tight against the bracket.

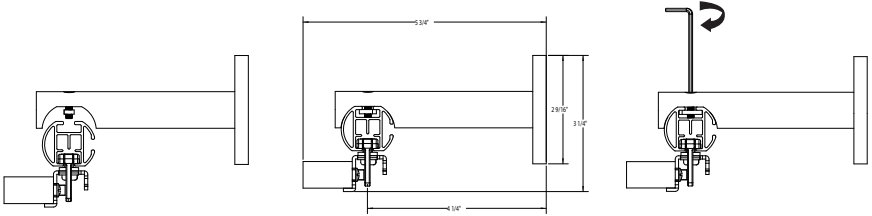

- **For Hidden Brackets**, hook the back of the rod onto the bracket and tighten the set screw until the rod is tight against the bracket.

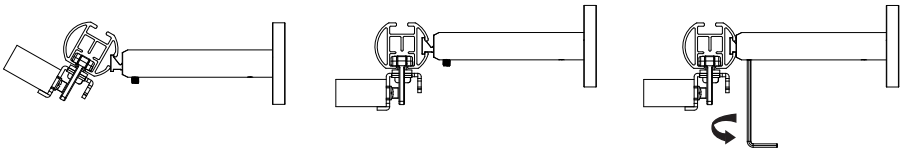

- **For Ceiling Brackets**, loosen the set screw and position evenly spaced according to the bracket spacing then tighten the set screw.
- Attach to the ceiling using the required hardware and put the cover on the bracket.

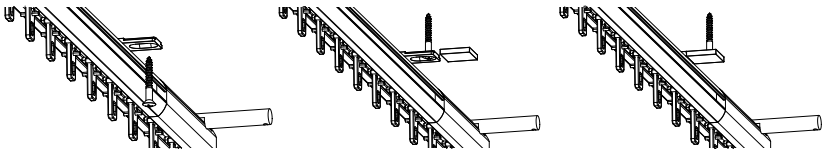

- Hang the drapery on the rod starting at the master carrier and moving out to the end of the rod.

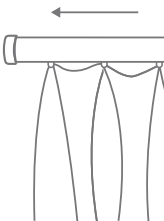

INSTALLATION

Install the Motor

- Slide the lead carrier(s) into a half open position.
- Attach the motor to the track.
 - Insert the motor diagonally into the driver cap.



- Press and hold the lock button on the motor, while rotating the motor. Release the lock button once the motor is in place.



- Plug the 24V DC power supply into the motor.
- Connect the AC plug from the power supply into a wall receptacle.



Setting Close and Open Limits

On initial power up, the LED on the motor will briefly blink green. The motor limits need to be set, in the order listed below:

- First move the carriers to the fully open position, where the drapery would be positioned when stacked back.
- Move the carriers to the fully closed position.
- Move the carriers again to the fully open position to finish establishing the limits.

Testing the Drapery

Testing the drapery will allow you to ensure that the motor and power source are working correctly.

CAUTION: The drapery should be installed before following the steps below.

- Press the "PV" button (located on the motor) to alternately traverse closed, stop, and traverse open the drapery.
- The PV button can also be used in combination with the PowerView App for control of advanced drapery functions and home access. Open the App, then press and hold the PV button to see a list of available functions. See "Operating the PowerView App and Gen 3 Remote" on page 8-9 for more information.

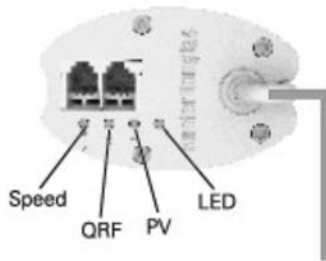

OPERATION

Further Operation and Programming Information

PowerView® App

The PowerView® App is required to program PowerView Gen 3 drapes, remotes, and gateways. The App is compatible with Apple® and Android™ smartphones and tablets. For more information regarding setup and operation using the PowerView App, refer to <https://help.hunterdouglas.com/s/powerview-gen-3-automation>.

PowerView® Gen 3 Gateway

The PowerView® Gen 3 Gateway is used to control drapes in larger projects as well as integrate PowerView Gen 3 drapes with third-party integration systems. For information regarding programming of PowerView Gen 3 Gateways, refer to the digital [PowerView Gen 3 Automation Gateway Guide](#).

PowerView Gen 3 Remote

For more information regarding operation and programming of the PowerView Gen 3 Remote, refer to the digital [PowerView Gen 3 Automation Remote Control Guide](#).

Operating the PowerView App and Gen 3 Remote

Syncing and Programming Your Remote

- Activate the remote by pulling both plastic tabs from the back battery compartment.
- Download the PowerView® App for your smartphone or tablet at hdpvapp.com.
- Open the PowerView App and follow the steps to set up your new drapes and remote.
- Use the PowerView App to program and manage your PowerView Gen 3 remote(s) as accessories.
- For more details, refer to the digital [PowerView Gen 3 Automation Remote Control Guide](#).

Basic Operation

- Wake up the remote by picking it up or pressing ■ STOP.
- Press group number(s) 1, 2, 3, 4, 5, and/or 6 to select one or more groups. Selected group numbers light up white on the remote.
- Press selected group number(s) 1, 2, 3, 4, 5 and/or 6 a second time to deselect one or more groups. Deselected group numbers are not lit.

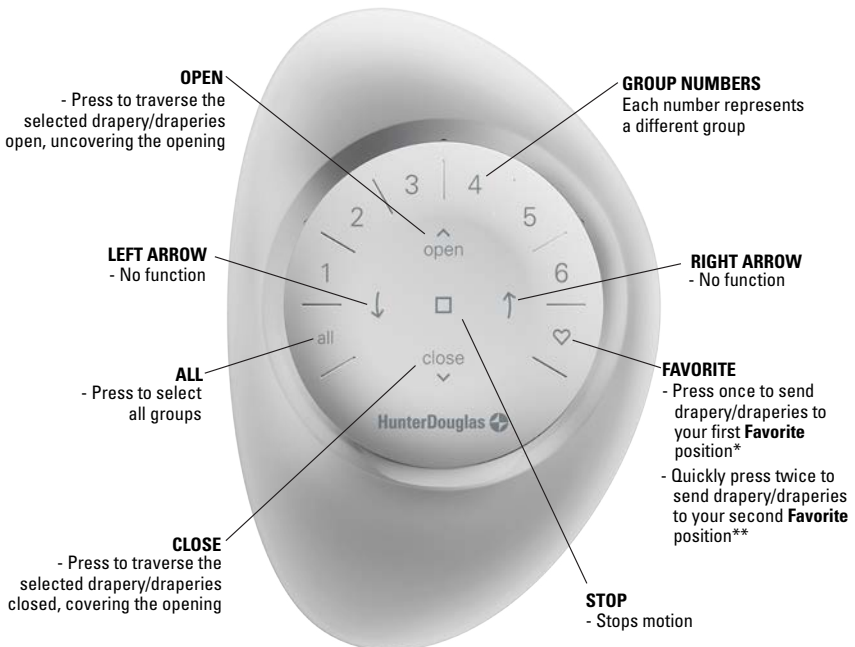

*The default first **Favorite** position is the drapery/draperies at 50% open.

Both preset **Favorite can be updated in the PowerView® App > Shade Settings.

OPERATION

Resetting the Drapery

Resetting Drapery Programming

The PowerView App may be used to modify or reset any drapery programming to PowerView Gen 3 Remotes and Gateways. Draperies may be added to or removed from Rooms in the app at any time. If necessary, draperies may also be deleted from the PowerView App in the Advanced Options section of the Shade Settings menu.

Reset End Limits

- Press and hold the “QRF” button on the motor for 3 seconds, until an LED lights up. Release the button, and then quickly follow the next steps within 15 seconds.
- Press and release the “QRF” button 3 times. The LED will blink three times to indicate that the limits have been cleared.
- Proceed to set the limits, as instructed on page 7.

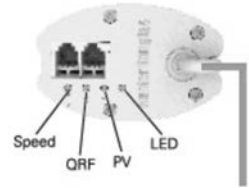

Press Button for
3 seconds with Pen

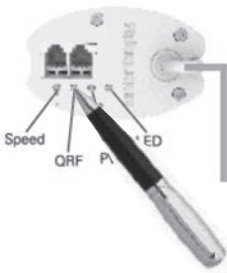

Press and release
the QRF Button
3 times with Pen

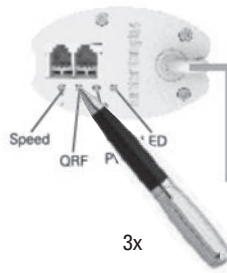

Set Drapery Speed

Adjust Drapery Speed

- To adjust the drapery speed, press the “Speed” button on the motor for 1 second and release.
- The LED color and motor speed will change accordingly, between 100rpm (green) and 120rpm (red).
- Press the “Speed” button again to toggle back to the previous speed.
- By default, the speed is set to 100rpm.

NOTE: On power up, the motor LED will blink briefly the color corresponding to the current speed setting. Out of the box, that is going to be green. However, that color will change if the speed is changed, to red.

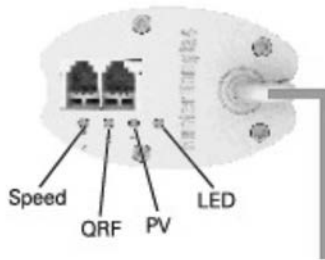

TROUBLESHOOTING

Troubleshooting

If your drapery is not operating correctly:

- Review the [digital support guide](#) for your control device.
- Refer to the following troubleshooting procedures for specific solutions for your drapery.

If questions remain, please contact Carole Fabrics Customer Service Department at **(800) 241-0920**.

Problem	PowerView Gen 3 only: The drapery does not respond to the remote.
Solution	<p>IMPORTANT: A drapery will not operate until it is joined to a group.</p> <p>Check that the correct group number is selected. The LED on that group number will light up. You can also check which group number the drapery is joined to on the remote in the PowerView App. You can find this under MORE > ACCESSORIES in the app.</p> <p>Check if the batteries need to be replaced. If the batteries are completely drained, none of the lights will turn on. If batteries are running low, the numbered groups on the remote will begin to illuminate in sequence after each button press, similar to the action seen when syncing a remote. In either case, the batteries need to be replaced. The remote takes two CR2032 batteries.</p>
Problem	The drapery limits need to be adjusted – open limits.
Solution	See “Setting Close and Open Limits” on page 7.
Problem	The drapery limits need to be adjusted – close limits.
Solution	See “Setting Close and Open Limits” on page 7.
Problem	The drapery does not operate using the PV button.
Solution	<p>Check that the DC power supply is securely connected to the AC outlet and to the motor.</p> <p>CAUTION: Be sure to unplug the DC power supply from the wall outlet before disconnecting the plug at the motor.</p>

Problem	The unit does not traverse at all, does not traverse fully, or does not traverse correctly.
Solution	<p>Check that the mounting brackets are level, that their front edges are aligned, and that there are no obstructions to the movement of the panels.</p> <p>Check the drapery's status in the PowerView App. See "Operating the PowerView App and Gen 3 Remote" on page 9 for more information.</p>
Problem	The drapery closes when ▲ OPEN is pressed and opens when ▼ CLOSE is pressed.
Solution	<p>The motor's direction needs to be reversed. To fix this, follow the steps below.</p> <p>Press and hold the "QRF" button on the motor for 3 seconds. When the LED lights up, release the "QRF" button and continue the next step within 15 seconds.</p> <p>Press and release the "Speed" button. The motor LED will blink 3 times to indicate the setting is complete.</p> <p>NOTE: Another solution would be to delete the drapery from the app, while in range of the shade. Then add the drapery to the home again, and make sure to select the correct "Left Stack," "Right Stack," or "Split Stack" option.</p>
Problem	I am replacing the motor. How do I remove the motor from the track?
Solution	<p>Press and hold the lock button on the motor, and then rotate the motor. Remove the motor and release the lock button.</p> <p>NOTE: Another solution would be to delete the drapery from the app, while in range of the shade. Then add the drapery to the home again, and make sure to select the correct "Left Stack," "Right Stack," or "Split Stack" option.</p>

DECLARATIONS

FCC Compliance Statement

NOTE: This equipment has been tested and found to comply with the limits for a Class B digital device, pursuant to part 15 of the FCC Rules. These limits are designed to provide reasonable protection against harmful interference in a residential installation. This equipment generates, uses and can radiate radio frequency energy and, if not installed and used in accordance with the instructions, may cause harmful interference to radio communications. However, there is no guarantee that interference will not occur in a particular installation. If this equipment does cause harmful interference to radio or television reception, which can be determined by turning the equipment off and on, the user is encouraged to try to correct the interference by one or more of the following measures:

- Reorient or relocate the receiving antenna.
- Increase the separation between the equipment and receiver.
- Connect the equipment into an outlet on a circuit different from that to which the receiver is connected.
- Consult the dealer or an experienced radio/tv technician for help.

NOTE: Changes or modifications not expressly approved by the manufacturer responsible for compliance could void the user's authority to operate the equipment.

Responsible party:

Hunter Douglas Window Fashions, Inc.

1 Duette Way

Broomfield, CO 80020

USA

help.hunterdouglas.com

ISED Canada compliance statement

This device contains licence-exempt transmitter(s)/receiver(s) that comply with Innovation, Science and Economic Development Canada's licence exempt RSS(s).

This Class B digital apparatus complies with Canadian ICES-003

Operation is subject to the following two conditions: (1) This device may not cause interference. (2) This device must accept any interference, including interference that may cause undesired operation of the device.

Cet appareil contient des émetteurs/récepteurs sans licence qui sont conformes aux RSS sans licencié d'Innovation, Sciences et Développement économique Canada.

Cet appareil numérique de la classe B est conforme à la norme NMB-003 du Canada.

Le présent appareil est conforme aux CNR d'ISDE Canada applicables aux appareils radio exempts de licence.

L'exploitation est autorisée aux deux conditions suivantes : (1) l'appareil ne doit pas produire de brouillage, et (2) l'appareil doit accepter tout brouillage radioélectrique subi, même si le brouillage est susceptible d'en compromettre le fonctionnement.

